

5. Setup the Aprisa SR radio

The Aprisa SR has a factory default Terminal Operating Mode of Remote Station.

One radio in the Aprisa SR network must be setup as a Base Station.

The other radios in the Aprisa SR network are setup as Remote Stations or Repeater Stations.

Set the Ethernet Operating Mode.

Set the unique radio Network ID to be the same in your entire network including the Base Station ID.

Set the Aprisa SR TX Frequency, RX Frequency, TX Power and Channel Size to comply with your site license.

Set the Antenna Port Configuration required.

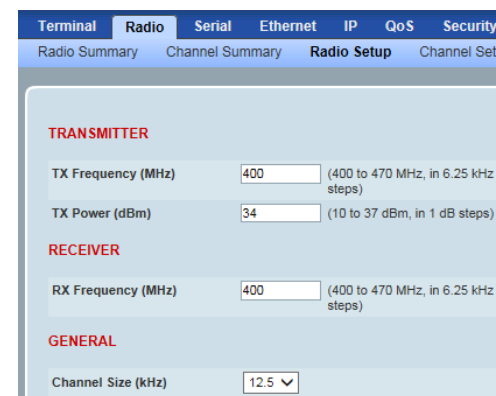
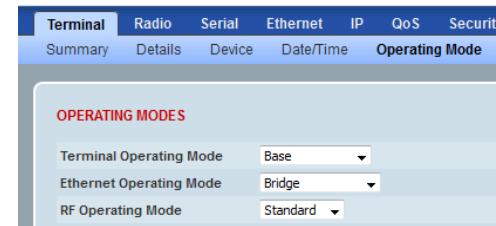

You can now configure the remaining terminal and network parameters and settings. Please refer to the Aprisa SR User Manual for detailed instructions.

6. Monitor the Aprisa SR radio signal strength

When the network is installed, the radio signal strength can be monitored on remote stations by setting the radio to Test Mode.

To enter Test Mode, press and hold the TEST button on the radio LED panel until all the LEDs flash green (about 3 - 5 seconds).

In Test Mode, the LED Display panel presents a real time visual display of the RSSI. This can be used to adjust the antenna for optimum signal strength.

Note: The response time is variable and can be up to 5 seconds.

To exit Test Mode, press and hold the TEST button until all the LEDs flash red (about 3 - 5seconds).

The OK, MODE and AUX LEDs will be solid green and the TX and RX LEDs will be solid or flash green if the network is operating correctly.

OK LED	MODE LED	AUX LED	TX LED	RX LED	RSSI
●	●	●	●	●	>= -80 dBm
●	●	●	●	●	-84 dBm to -81 dBm
●	●	●	●	●	-88 dBm to -85 dBm
●	●	●	●	●	-92 dBm to -89 dBm
●	●	●	●	●	-96 dBm to -93 dBm
●	●	●	●	●	-100 dBm to -97 dBm
●	●	●	●	●	-104 dBm to -101 dBm
●	●	●	●	●	-108 dBm to -105 dBm
●	●	●	●	●	-112 dBm to -109 dBm
●	●	●	●	●	-116 dBm to -113 dBm
●	●	●	●	●	< RSSI threshold
●	●	●	●	●	No response received

For more information, please refer to the Aprisa SR User Manual available from the 4RF website www.4rf.com/secure/ (login required).



Quick Start Guide

Aprisa SR Radio

Contents

Follow these steps to operate your Aprisa SR radio:

1. Check the box contents
2. Install the Aprisa SR radio and connect the protection earth
3. Connect the Antenna and apply power to the Aprisa SR radio
4. Connect to the Aprisa SR radio
5. Setup the Aprisa SR radio
6. Monitor the Aprisa SR radio signal strength

1. Check the box contents

The Aprisa SR is shipped to you in a box containing the following:

(i). An Aprisa SR radio fitted with a power connector. The Aprisa SR has two antenna port product options:

Single Antenna Port

Example; part number APSX-N400-SSC-SQ-22-ENAA



Dual Antenna Port

Example; part number APSX-N400-SSC-DO-22-ENAA



(ii) USB Cable USB A to USB micro B, 1m

Used for Command Line Interface management (see Aprisa SR User Manual)

2. Install the Aprisa SR radio and connect the protection earth

The Aprisa SR has four threaded holes (M4) in the base and two holes (for M5 screws) through the enclosure for mounting. Mounting options include:

- DIN rail mounting with the Aprisa SR Mounting Bracket (optional accessory part number 'APSB-MBRK-DIN')
- Wall and rack shelf mounting
- Outdoor enclosures

The Aprisa SR mounting options are shown below:

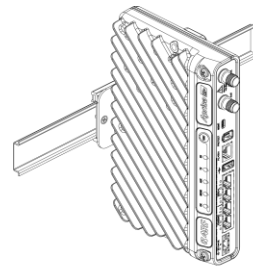

DIN Rail Vertical Mount

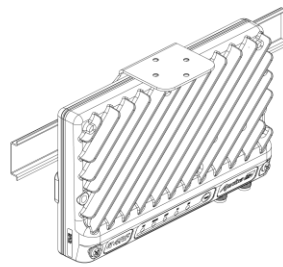

DIN Rail Flat Horizontal Mount

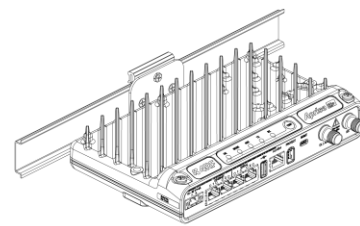

DIN Rail Horizontal Mount

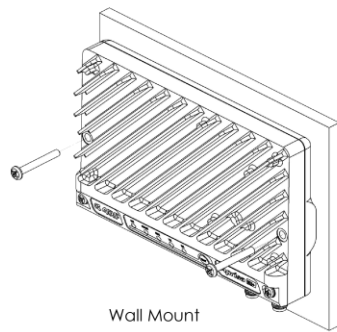

Wall Mount

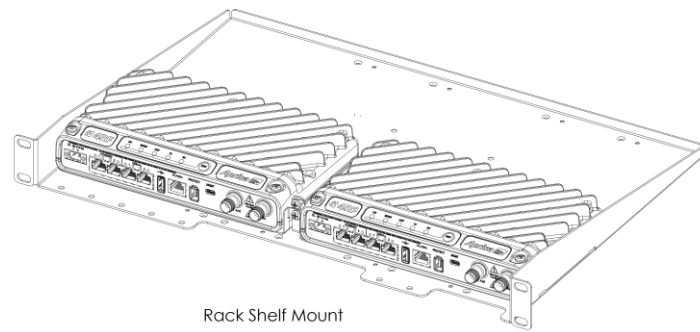

Rack Shelf Mount

The Aprisa SR has an earth connection point on the top left and the top right of the enclosure. Use the supplied M4 screws to earth the enclosure to a protection earth.

The antenna feeder cable should use grounding kits for lightning protection as specified or supplied by the coaxial cable manufacturer to properly ground or bond the cable outer.



Warning: If the Aprisa SR is operated in an environment where the ambient temperature exceeds 50°C, the Aprisa SR must be installed within a restricted access location to prevent human contact with the enclosure heatsink.

Note: The Aprisa SR radio operates within frequency bands that require a site license be issued by the radio regulatory authority with jurisdiction over the territory in which the equipment is being operated. It is the responsibility of the user, before operating the equipment, to ensure that where required the appropriate license has been granted and all conditions attendant to that license have been met.

Hereby, 4RF Limited declares that the Aprisa SR digital radio is in compliance with Directive 2014/53/EU. The full text of the EU declaration of conformity is available at the internet address <http://www.4rf.com/library/en>.

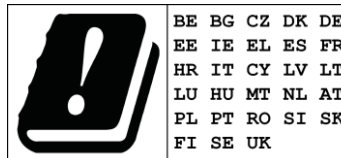

3. Connect the antenna and apply power to the Aprisa SR radio

Connect the antenna to the antenna port TNC female connector. If the antenna is not available, terminate the 'TX / Ant' port with a TNC male 50 ohm terminator (10 Watts min).

Warning: Do not directly connect the two radio antenna ports without attenuation of at least 40 dB. The receiver can be damaged if signals greater than +10 dBm are applied to the antenna port.

The Aprisa SR is operated from a DC source of voltage between +10 VDC and +30 VDC (negative earth) and consumes up to 35 Watts. External power supplies are available from 4RF as accessories (see the Aprisa SR User Manual).

The power connector (Molex 2 pin female) is supplied fitted to the radio. Wire your power source to the power connector (- / +) and plug the connector into the radio. The connector screws should be fastened to secure the connector.

Note: The radio fuses will blow if the connected power supply is over voltage or the polarity is reversed. Two spare fuses are located inside the enclosure (see the 'Spare Fuses' section of the Aprisa SR User Manual).

Turn your power source on. The radio LEDs will flash orange for one second and then the OK, MODE, AUX LEDs will light solid green and the TX and RX LEDs will flash red. This is because the factory default Terminal Operating Mode for all Aprisa SR radios is set to Remote Station.

When the radio has been configured and has registered with the network, the TX and RX LEDs will be solid or flash green if the network is operating correctly.

The Aprisa SR radio is ready to operate.

Warning: On link operation, RF energy is radiated from the antenna. Do not stand in front of the antenna.



4. Connect to the Aprisa SR radio

The Aprisa SR has a factory default IP address of 169.254.50.10 with a subnet mask of 255.255.0.0.

Each radio in the Aprisa SR network must be setup with a unique IP address on the same subnet.

If the IP address of the radio is unknown, it can be changed via the Command Line Interface on the radio MGMT USB port:

- Connect your PC USB port to the Aprisa SR MGMT USB port. USB to UART Bridge VCP Drivers are required to connect the radio USB port to your PC. You can download and install the relevant driver from <https://www.silabs.com/products/development-tools/software/usb-to-uart-bridge-vcp-drivers>.
- Login to the radio with the default login 'admin' and password 'admin'.
- At the command prompt >> type 'cd APRISASR-MIB-4RF' and enter.
 - type 'set termEthController1IpAddress xxx.xxx.xxx.xxx' and enter.
 - type 'set termEthController1SubnetMask 255.255.0.0' and enter.
 - type 'set termEthController1Gateway xxx.xxx.xxx.xxx' and enter.

If the IP address of the radio is known or is the default IP address, it can be changed via the Ethernet port:

- Setup your PC for a compatible IP address e.g. 169.254.50.1 with a subnet mask of 255.255.0.0.
- Connect your PC network port to one of the Aprisa SR Ethernet ports.
- Open a browser and enter <http://169.254.50.10>.

Note: The Aprisa SR has a Self Signed security certificate which may cause the browser to prompt a certificate warning. It is safe to ignore the warning and continue. The valid certificate is 'Issued By: 4RF-APRISA' which can be viewed in the browser.

- Login to the radio with the default login 'admin' and password 'admin'.
- Change the IP address, Subnet mask and Gateway to network compatible IP addresses.

